

Microphones

Speech / Spoken Word

99er Series

CK99 L



Low-profile, cost efficient clip-on microphone. Connects to AKG bodypack transmitters. Provides a natural sound, with a slight rise above 10 kHz for added clarity.

CK99 L	AKG0759	RRP: £134.17
--------	---------	--------------

CGN99 C

The CGN99, part of the DAC Series, are condenser gooseneck microphones with a cardioid polar pattern. They are specially designed for inexperienced speakers who talk into the microphone from widely varying angles.

The rugged gooseneck has a length of 30cm or 50cm and are ideal for fixed and mobile installations. CGN99 comes with an integrated XLR phantom power adapter with 250Hz bass rolloff. The phantom power adapter connects to any standard mixer input with 9V to 52V power supply.



CGN99 C/S	AKG0760	RRP: £190.00
CGN99 C/L	AKG0761	RRP: £190.00

CGN99 H

The CGN99 H, part of the 99er series, is a condenser gooseneck microphone with a hypercardioid polar pattern. They are a good choice for all situations when unwanted noise arrives from the sides or where people talk into the microphone from greater distances. The gooseneck is 30cm or 50cm long and ideal for fixed and mobile installations. CGN99 H comes with an integrated XLR phantom power adapter with 250Hz bass rolloff. The phantom power adapter connects to any standard mixer input with 9V to 52V power supply.



CGN99 H/S	AKG0762	RRP: £190.00
CGN99 H/L	AKG0763	RRP: £190.00

CHM99

The CHM99, part of the 99ers Series, is a hanging microphone module with cardioid polar pattern, used to record music or speech in houses of worship, conference rooms or on theatre stages. The CHM99 is available in black or white. A 10m (33ft) special cable that is treated specially to reduce twisting to a minimum and a spring steel hanging clamp for precise microphone alignment keeps the microphone securely in its position. The attached phantom power adapter connects to any standard mixer input with 9V to 52V power supply.



CHM99 black	AKG0764	RRP: £190.00
CHM99 white	AKG0765	RRP: £190.00

DGN99

The DGN99 is a dynamic gooseneck microphone with cardioid polar pattern for general public address and communication use. The microphone provides a frequency response tailored for optimum intelligibility, good off-axis rejection for high gain before feedback and suppression of unwanted ambient noise. The all-metal body ensures a long, useful life for the microphone even in tough day-to-day use. The DGN99 is unterminated with a 2m cable. The DGN99E features a built-in 3-pin XLR connector.



DGN99	AKG0767	RRP: £190.00
DGN99 E	AKG0768	RRP: £190.00

DST 99 S

Dynamic cardioid gooseneck microphone for general public address and communications use. Frequency response tailored to speech use for optimum intelligibility as well as good off axis rejection for high gain before feedback and suppression of unwanted ambient noise. Mounted on a table stand with an on/off switch and coiled cable with 3-pin XLR connector.



DST99 S	AKG0769	RRP: £190.00
---------	---------	--------------

DAM+ Series Gooseneck Modules

GN15 / 30 / 50 M

Premium gooseneck module for permanent and mobile installations. 15, 30 or 50cm. Features a discrete LED ring which indicates whether the microphone is on or off. A light-ring expander is available to improve visibility of the LED if required. Pair with a CK41, CK43 or CK49 capsule and PAESP M, PAES M or PAE M powering module.



GN15 M	AKG0887	RRP: £123.33
GN30 M	AKG0889	RRP: £150.00
GN50 M	AKG0890	RRP: £200.83

CGN341 E

DAM+ series tabletop microphone set that provides the components needed to handle a wide range of applications with the flexibility to cover a variety of situations. Includes the CK41 Reference Cardioid Condenser Microphone Capsule, the W40 M windscreen, the GN30 M Reference DAM+ series gooseneck module and the PAE M Reference Phantom Power Module.





CGN341E DAM+ SET	AKG1024	RRP: £417.50
------------------	---------	--------------

Hanging Module

HM1000M		
<p>Hanging module. 10m cable that will not twist. Features a discrete LED ring which indicates whether the microphone is on or off. A light-ring expander is available to improve visibility of the LED if required. Pair with a CK41, CK43 or CK49 capsule and PAESP M, PAE5 M or PAE M powering module.</p>		
		
HM1000 M	AKG0891	RRP: £108.33

Capsules

CK41		
<p>Cardioid capsule for Modular Plus gooseneck series. 125° pickup pattern.</p>		
		
CK41	AKG0879	RRP: £200.83

CK49		
		
<p>Hypercardioid shotgun capsule for Modular Plus gooseneck series. 80° pickup pattern.</p>		
CK49	AKG0881	RRP: £375.83

Power Modules

PAESPM		
<p>Programmable powering module with noiseless switch. Binary switches for bass roll off, LED ring mode, and mic mode (push to mute, push to talk, latching). 9-52V phantom powering.</p>		
		
PAESP M	AKG0898	RRP: £150.00

PAE5M		
<p>Phantom powering module. 5 pin XLR connector for use with automixers including logic outputs to control LED ring. 9-52V phantom powering. Switchable bass roll off.</p>		
		
PAE5 M	AKG0897	RRP: £123.33

PAEM		
<p>Phantom powering module for Modular Plus series. 9-52V phantom powering. Switchable bass roll off.</p>		
		
PAE M	AKG0896	RRP: £92.50

Stands

STS DAM+		
<p>Heavy duty metal table stand with excellent shock absorbing properties. LED status square. Programmable switch for push to talk, push to mute, push on/off and low cut on/off functions. 4-pin connector compatible with all MODular Plus series microphones.</p>		
		
STS DAM+	AKG0960	RRP: £360.00

STS DAM+ WLS		
<p>Table top gooseneck base for wireless use. Compatible with most AKG pocket transmitters (PT40/45/420/470 and DPT700/800). Accepts DAM+ goosenecks and capsules for all needs. 3.5mm input for connecting external sources. Mute switch with LED bar.</p>		
		
STS DAM+ WL	AKG0990	RRP: £391.67

Accessories

MFM		
<p>Mounting flange for use with Modular Plus Series.</p>		
		
MF M	AKG0893	RRP: £66.67

DAM Series Gooseneck Modules

CGN331E		
<p>DAM series gooseneck combo, consisting of the CK31 cardioid capsule and GN30E gooseneck. Works in fixed or mobile installations and comes with integrated XLR phantom power adaptor with 250Hz bass rolloff and LED ring. It connects to any standard mixer input with 9-52v power supply.</p>		
		
CGN331E	AKG1023	RRP: £330.00

GN15 / 30 / 50

Permanent screw-on installation goosenecks. 15 cm length. Integrated LED ring status indicator. DPA in-line XLR phantom power adapter with integrated 200 Hz bass rolloff and LED ON/OFF jumper. The mini XLR connector will thread through any hole from 11 mm (0.44 in.) in diameter. Use with CK31, CK32, CK33, CK47 or CK80 capsules.



CS3DU30 ?	AKG0170	RRP: £283.33
GN30 incl. DPA, screw set	AKG0175	RRP: £325.00
GN30 OC	AKG0179	RRP: £195.00
GN50 incl. DPA, screw set	AKG0180	RRP: £325.00

GN15 / 30 / 50 E

Gooseneck with integrated XLR connector for quick setup and takedown. 15, 30 or 50 cm lengths. Integrated 200Hz bass cut filter and LED ring status indicator. Use with CK31, CK32, CK33, CK47 or CK80 capsules.



GN15 E incl. DPA	AKG0171	RRP: £267.50
GN30 E incl. DPA	AKG0156	RRP: £309.17
GN50 E incl. DPA	AKG0182	RRP: £325.00
GN50E inc DPA	AKG0182	RRP: £315.00

GN155SET

Gooseneck floor stand. Two integrated flexible gooseneck sections allow optimum alignment with talkers of different heights or positions. Supplied screw-on extension tube can be used to place the microphone higher for tall talkers. Integrated LED ring. Supplied with 10m cable with phantom power adaptor. Use with CK31, CK32, CK33, CK47 or CK80 capsules.



GN155 Set	AKG0150	RRP: £618.33
-----------	---------	--------------

GN15 / 30 / 50 E 5 PIN

As above but with 5 pin XLR which allows the LED ring to be controlled remotely, for example from the logic out of a mixer. Extra large LED ring for visibility. Available in 15cm, 30cm, or 50cm gooseneck lengths.



GN15E 5 PIN	AKG0570	RRP: £160.00
GN30 E 5-pin	AKG0571	RRP: £309.17
GN50 E 5-pin	AKG0573	RRP: £325.00

GN15 / 30 / 50 ESP

Gooseneck with integrated XLR connector and programmable mute switch (on/off, push-to-talk, push-to-mute). 15cm, 30cm or 50cm length. Integrated 200Hz bass cut filter and LED ring status indicator. Use with CK31, CK32, CK33, CK47 or CK80 capsules.



GN15 ESP incl. windscreen	AKG0639	RRP: £325.00
GN30 ESP incl. windscreen	AKG0638	RRP: £360.83
GN50 ESP incl. windscreen	AKG0640	RRP: £391.67

Hanging Module

HM1000

Hanging choir module. Integrated LED ring. Supplied with 10m cable with phantom power adaptor. Use with CK31, CK32, CK33, CK47 or CK80 capsules.



HM1000	AKG0190	RRP: £236.67
--------	---------	--------------

Capsules

CK31

Cardioid capsule for modular gooseneck series. 125° pickup pattern.



CK31	AKG0077	RRP: £93.33
------	---------	-------------

CK33		
Hypercardioid capsule for modular gooseneck series. 95° pickup pattern.		
		
CK33	AKG0079	RRP: £195.83

CK80		
		
Speech-optimised hypercardioid shotgun capsule for modular gooseneck series. 80° pickup pattern.		
CK80	AKG0038	RRP: £75.00

Accessories

H500		
Elastic shockmount for goosenecks with integrated XLR.		
		
H500	AKG0207	RRP: £50.00

H600		
Shockmount for GN model goosenecks.		
		
H600	AKG0384	RRP: £185.00

Paging Microphones

CGN321 STS		
Table top gooseneck microphone with programmable switch. Based on the heavy duty STS DAM+ stand, this microphone has a slim and elegant 30cm gooseneck with cardioid capsule, extremely rugged switch programmable for push to talk, push to mute, push on/off, low cut on/off, and an LED square. The output is a gold-plated 3-pin XLR socket.		
		
CGN321STS	AKG0958	RRP: £375.83

CGN521 STS		
Table top gooseneck microphone with programmable switch. Based on the heavy duty STS DAM+ stand, this microphone has a slim and elegant 50cm gooseneck with cardioid capsule, extremely rugged switch programmable for push to talk, push to mute, push on/off, low cut on/off, and an LED square. The output is a gold-plated 3-pin XLR socket.		
		
CGN521STS	AKG0959	RRP: £401.67

USB Microphones

Ara		
The Ara is the latest mic from the legendary AKG brand. It's perfect for podcasting, video blogging, gaming, streaming and more. It uses class-compliant drivers, so it works with everything. The base stand can be disconnected for use on a mic stand or with a boom arm. It has a built-in headphone jack, so you can monitor your audio as well. And, it ships with a USB cable and free recording software - you're all set with the new AKG Ara.		
		
Ara C22-USB	AKG1197	RRP: £87.50

Lavalier & Headworn Microphones

C417		
Affordable professional miniature condenser microphone. Its broadband, flat audio reproduction in an omnidirectional format is ideal for all types of broadcast and theatrical applications. The sound is extremely open and natural, making it ideal for wireless or hardwire multi-mic situations. An attachment clip, tiepin, and windscreen are supplied with each C417. The C417 PP features a standard XLR connector while the C417 L provides a professional three-pin mini XLR connector that fits the body pack transmitters of all AKG wireless microphone systems.		
		
C417 L	AKG0090	RRP: £107.50
C417 PP	AKG0026	RRP: £145.83

CK97C/L		
Lavalier mic capsule for Blue Line series		
		
CK97 C/L	AKG0903	RRP: £220.00

C111 LP		
<p>Ultralight high-performance ear hook microphone for presentations and theatre applications. Weighing an amazingly light 7g, the C111LP is comfortable to wear during even the longest performances. Delivered with a carrying pouch, windscreen and cable clip, it is suitable for all AKG pocket transmitters.</p>		
		
C111 LP	AKG0973	RRP: £150.00

C520		
<p>Head worn condenser mic. Ideal choice for vocals, instrumentalists and dancers. Moisture shield prevents sweat from penetrating the transducer. Adjustable headband. C520 has a standard XLR connector. C520L has mini XLR for connecting to WMS transmitters, B23L or MPA VL adaptors.</p>		
		
C520	AKG0631	RRP: £314.17
C520 L	AKG0633	RRP: £231.67

C544 L		
<p>Light, rugged head-worn condenser microphone. Cardioid polar pattern. Ergonomically optimized behind-the-neck headband, external shock mount for high mechanical-noise rejection. Moisture shield.</p>		
		
MK HS XLR 5D	AKG0814	RRP: £115.83

C555 L		
<p>Headworn condenser. Adjustable behind-the-neck headband. Mic arm can be used on left or right side. Moisture shield and shockmount. Mini XLR for connecting to WMS transmitters, B23L or MPA VL adaptors.</p>		
		
C555 L	AKG0593	RRP: £104.17

Microlite

EC81 MD		
<p>Designed for theatre, broadcast, musical performances and conferences, the EC81 MD reference lightweight cardioid ear-hook microphone is engineered for accurate, specific placement. Featuring a flexible ear-hook and adjustable boom length, it's easy for the wearer to find the perfect fit without any help. Microdot connector works with all major wireless systems. Available in two colours.</p>		
		
EC81MD beige	AKG1083	RRP: £638.33
EC81 MD Cocoa	AKG1084	RRP: £470.00

MDA1 AKG		
<p>The MDA1 AKG adapter connector AKG® links every AKG MICROLITE microphone with an AKG® bodypack transmitter with 3-pin Mini-XLR input.</p>		
		
MDA1 AKG	AKG1100	RRP: £92.50

MDA2 SEN1		
<p>The MDA2 SEN1 adapter links every AKG MICROLITE microphone with a Sennheiser® 2000, 3000, 5000 bodypack transmitter with 3-pin Lemo input.</p>		
		
MDA2 SEN1	AKG1101	RRP: £130.00

MDA3 SEN2		
<p>The MDA3 SEN2 adapter links every AKG MICROLITE microphone with a Sennheiser® bodypack transmitter with 3.5 mm jack input.</p>		
		
MDA3 SEN2	AKG1102	RRP: £92.50

MDA4 SHU		
<p>The MDA4 SHU adapter Shure®* links every AKG MICROLITE microphone with a Shure® bodypack transmitter with TA4F input.</p>		
		
MDA4 SHU	AKG1103	RRP: £92.50

MDA5 AT		
<p>The MDA5 AT adapter connector Audio-Technica®* links every AKG MICROLITE microphone with an Audio-Technica® bodypack transmitter with 4-pin locking connector.</p>		
		
MDA5 AT	AKG1104	RRP: £92.50

MDA6 BD		
<p>The MDA6 BD links every AKG MICROLITE microphone with a Beyerdynamic® bodypack transmitter with 4-pin Mini-XLR connector.</p>		
		
MDA6 BD	AKG1105	RRP: £92.50

MDA7 LEC

The MDA7 LEC adapter links every AKG MICROLITE microphone with a Lectrosonics® bodypack transmitter with 5-pin locking (TA5F) connector.



MDA7 LEC	AKG1106	RRP: £92.50
----------	---------	-------------

H1 Magnet Clip

Holds the microphone housing, instead of the delicate cable to ensure a tight hold as well as protecting the cable from breaking. Using the magnet, the clip can be mounted almost everywhere. Available in white and black.



H1 magnet clip black 5 pack	AKG1108	RRP: £133.33
H1 magnet clip white 5 pack	AKG1109	RRP: £133.33

H2 Croco Clip

The H2 croco—a standard "crocodile" clip—is part of the MicroLite series and holds the microphone housing, instead of the delicate cable to ensure a tight hold as well as protecting the cable from breaking. It comes in two colors -white and black. Pack of five pieces.



H2 croco clip black 5 pack	AKG1110	RRP: £133.33
H2 croco clip white 5 pack	AKG1111	RRP: £133.33

WM81 Wire-mesh cap

Wire-mesh cap for cardioid Microlite microphones. Protects the membrane from wind and pop noise as well as dirt, makeup and dust. Colour coded to match the microphone. Pack of 5 pieces.



WM81 black wiremesh 5 pack	AKG1125	RRP: £108.33
WM81 white wiremesh 5 pack	AKG1126	RRP: £108.33
WM81 beige wiremesh 5 pack	AKG1127	RRP: £108.33
WM81 cocoa wiremesh 5 pack	AKG1128	RRP: £108.33

WM82 Wire-mesh cap

Wire-mesh cap for omnidirectional Microlite microphones. Protects the membrane from wind and pop noise as well as dirt, makeup and dust. Colour coded to match the microphone. Pack of 5 pieces.



WM82 black wiremesh 5 pack	AKG1121	RRP: £66.67
WM82 white wiremesh 5 pack	AKG1122	RRP: £66.67
WM82 beige wiremesh 5 pack	AKG1123	RRP: £66.67
WM82 cocoa wiremesh 5 pack	AKG1124	RRP: £66.67

W81 Windscreen

Foam windscreen cap for cardioid Microlite microphones. Fits on top of the of the wire-mesh protection cap (WM81). Colour coded to match the microphones. Pack of 10 pieces.



W81 black foam 10 pack	AKG1117	RRP: £55.00
W81 white foam 10 pack	AKG1118	RRP: £55.00
W81 beige foam 10 pack	AKG1119	RRP: £55.00
W81 Windscreen - 10 pack - cocoa	AKG1120	RRP: £38.00

W82 Windscreen

Foam windscreen cap for omnidirectional Microlite microphones. Fits on top of the of the wire-mesh protection cap (WM82). Colour coded to match the microphones. Pack of 10 pieces.



W82 black foam 10pack	AKG1113	RRP: £55.00
W82 white foam 10 pack	AKG1114	RRP: £55.00
W82 beige foam 10 pack	AKG1115	RRP: £55.00
W82 cocoa foam 10 pack	AKG1116	RRP: £55.00

MUP81 / MUP82 Makeup protector

Makeup protector, protects the microphone capsule during makeup application. MUP81 for cardioid microphones, MUP for omnidirectional microphones. Pack of 10 pieces.





MUP81 10 pack	AKG1130	RRP: £40.00
MUP82 10 pack	AKG1129	RRP: £40.00

Boundary Layer & Shotgun

C747 V11		
Premium pencil microphone, ubiquitous in lectern, theatre and broadcast applications. Speech optimised frequency range. Immune to RF interference. Enhanced hypercardioid polar pattern. High SPL capability.		
		
C747 V11	AKG0714	RRP: £1,025.00

C562 CM		
Flush-mount boundary layer microphone designed for permanent 'invisible' installations. High sensitivity making it perfect for surveillance, live recording or theatre use. Supplied XLR phantom power adaptor.		
		
C562 CM	AKG0119	RRP: £309.17

CBL301		
Triple element, professional low-profile boundary layer microphone for conference rooms, education spaces and meeting rooms. User configurable from 270 to 360 degrees. Touch I/O to change talk and mute state. RGB LED ring indicators provide clear visual cues to indicate current talk and mute state. RF interference suppression. Screw terminals for simple installation. Low profile design minimally disrupts the table surface.		
		
CBL301B	AKG1183	RRP: £757.50

CBL201		
Dual element, professional low-profile boundary layer microphone for conference rooms, education spaces and meeting rooms. 180 degree configuration. Touch I/O to change talk and mute state. RGB LED ring indicators provide clear visual cues to indicate current talk and mute state. RF interference suppression. Screw terminals for simple installation. Low profile design minimally disrupts the table surface.		
		
CBL201B	AKG1182	RRP: £602.50

CBL410 PCC		
Plug-and-play desktop microphone for use with any PC or laptop when making VOIP or conference calls. Omni-directional capsule picks up sound from all directions. 3.5mm stereo jack. Up to 5 units can be cascaded together for larger rooms and multi-person use. Available in black or white.		
		
CBL410 PCC black	AKG0851	RRP: £108.33
CBL410 PCC white	AKG0872	RRP: £108.33

C547BL		
Hypercardioid studio-quality boundary microphone. Non-crush case and switchable bass-cut filter. Easy to repaint if required.		
		
C547 BL	AKG0116	RRP: £618.33

PCC170		
Surface-mounted supercardioid microphone ideal for use on lecterns or boardrooms etc. Mic capsule ensures phase coherency up to the highest frequencies in the audible spectrum, resulting in a wide, smooth frequency response. RFI suppression. SW model has silent operating membrane switch which can be configured for touch on/off, momentary on or momentary off. SWO includes an extra pair of leads for remote sensing.		
		
PCC170	CRO0132	RRP: £480.00
PCC170 SW	CRO0134	RRP: £505.00
PCC170 SWO	CRO0136	RRP: £435.00

PCC160		
Surface-mounted supercardioid microphone for lecterns, conference tables and news desks. Phase Coherent Cardioid® uses a subminiature supercardioid mic capsule which improves gain-before-feedback, reduces unwanted room noise and rejects sounds from the rear. Capable of withstanding up to 120 dB SPL without distorting. A bass tilt switch allows the user to tailor the low-end response for particular applications.		
		
PCC160	CRO0130	RRP: £515.00

PCC130		
Surface-mounted boundary layer microphone. PCC® (phase coherent cardioid) technology prevents phase interference due to table sound reflections. Wide and smooth frequency response with 3-position bass-tilt switch. SW model has silent-operating membrane switch which can be configured for touch on/off, momentary on or momentary off and attenuates 70dB when off.		
		
PCC130	CRO0124	RRP: £445.00
PCC130 SW	CRO0009	RRP: £491.67

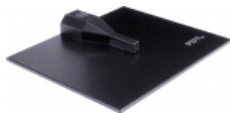
PZM30 D		
Pressure Zone Microphone designed for professional recording, sound reinforcement and broadcasting. Switchable dual frequency response (rising or flat), with excellent clarity and "reach". Hemispherical polar pattern, uncoloured off-axis response, and a wide smooth frequency response free of phase interference.		
		
PZM30 D	CRO0160	RRP: £600.00

PZM11		
Low-cost solution for security and surveillance applications. Mounted on a standard wall plate the PZM®-11 doesn't look like a microphone but rather an ordinary light switch. Hemispherical polar pattern with excellent intelligibility. Low frequency roll off to reduce HVAC rumble. Rear screw terminal connectors. Mic or line level versions (PZM-11LL)		
PZM11	CRO0152	RRP: £180.00
PZM11 LL	CRO0153	RRP: £115.00

PZM11 LL WR		
Weather resistant Pressure Zone Microphone® based on the PZM®-11 with a balanced, line-level output. Applications include fast-food restaurants, outdoor intercoms, toll booths, bridges, theme park security, home automation etc. Can be plugged directly into a VCR line input, no costly mic preamp is needed.		
PZM11 LL WR	CRO0155	RRP: £270.00

PZM10		
Inconspicuous pressure zone microphone for security, surveillance, and conference table use. Mounts easily into tables, walls or ceilings. Hemispherical polar pattern for clear, intelligible pickup of speech. PZM-10 powered by phantom power with inline XLR connector. PZM-10LL has line level output, is powered by 12-24v DC and has unterminated wires.		
PZM10	CRO0149	RRP: £215.00
PZM10 LL	CRO0151	RRP: £290.00

PZM6 D		
Pressure Zone Microphone® designed for professional recording, sound reinforcement and broadcasting. A smaller integral boundary makes the PZM®-6D even more inconspicuous than the PZM®-30D. Permanently attached cable with XLR connector.		
PZM6 D	CRO0035	RRP: £600.00

Micro Microphones

C430		
Condenser overhead microphone. Specially designed for cymbal and overhead miking. Battery or phantom power options. Mounts securely on most commercial stands.		
C430	AKG0100	RRP: £155.00

C411		
Ultra-light acoustic vibration pickup ideal for acoustic guitar, mandolin, violin and most other stringed instruments. Condenser transducer in sealed enclosure. Cable with locking miniature XLR connection. Included non-marring reusable solvent-free compound. Available with XLR connector (PP) or mini-XLR (L) for connection to wireless systems.		
C411 L	AKG0083	RRP: £115.83
C411 PP	AKG0084	RRP: £145.00

C516 ML		
Cardioid instrument mic with miniature mounting bracket. Ideal for miking up piano, guitar or keyboard amps. Included screws and double-sided adhesive pads for easy installation on instrument or amp. Mini XLR for connecting to WMS transmitters, B23L or MPA VL adaptors.		
C516 ML	AKG0582	RRP: £136.67

C518		
Clamp on miniature condenser mic. Ideal for drums and percussion. Cardioid pattern reduces spill. Adjustable vice clamp securely fixes the mic to the top hoop of drums or percussion instruments. M version has a full size XLR connector, the ML version has mini XLR for connecting to WMS transmitters, B23L or MPA VL adaptors.		
C518 M	AKG0584	RRP: £182.50
C518 ML	AKG0586	RRP: £173.33

C519		
<p>Miniature condenser mic for wind instruments and percussion. Cardioid pattern reduces spill. Clips on bell of any instrument. Detachable cable. M version has a full-size XLR connector, while the ML version has mini XLR for connecting to wireless transmitters, B23L or MPA VL adaptors.</p>		
		
C519 M	AKG0588	RRP: £181.67
C519 ML	AKG0590	RRP: £173.33

ULS Series

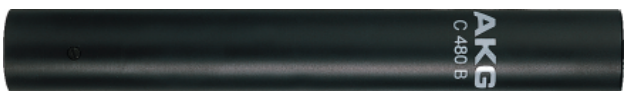
C480B ULS		
		
<p>Condenser preamplifier. Transformerless output stage assures linear transfer characteristics and low-self noise. Typical SPL of 140dB. Two-step high pass filter and two gain manipulation stages of -10dB and +6dB. Choice of various capsules.</p>		
C480 B-ULS	AKG0113	RRP: £715.00

CK61 ULS		
<p>Cardioid capsule. Includes W32 windshield.</p>		
		
CK61 ULS	AKG0678	RRP: £319.17

C480B Combo		
		
<p>Modular microphone consisting of the C480B preamplifier, CK61 capsule, foam windscreen and stand adaptor.</p>		
C480 B Combo	AKG0112	RRP: £1,020.83

CK62 ULS		
<p>Omni capsule. Includes W32 windshield.</p>		
		
CK62 ULS	AKG0030	RRP: £345.00

CK63 ULS		
<p>Hypercardioid capsule. Includes W32 windshield.</p>		
		
CK63 ULS	AKG0031	RRP: £345.00

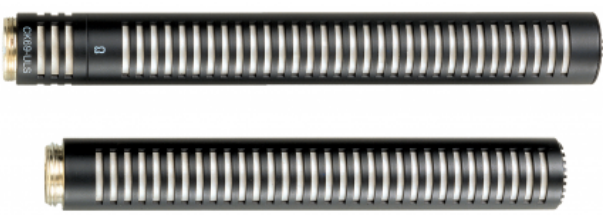
CK69 ULS		
		
<p>Shotgun capsule. Two capsules in one with easy conversion from hypercardioid to directional polar patterns.</p>		
CK69 ULS	AKG0032	RRP: £898.83

Blue Line

C391B		
		
<p>Versatile cardioid condenser microphone consisting of the SE300B powering/output module and CK91 capsule. Includes SA60 stand mount and W90 windshield.</p>		
C391 B	AKG0681	RRP: £479.17

CK91		
<p>Cardioid capsule. Includes W90 windshield.</p>		
		
CK91	AKG0039	RRP: £257.50

CK92		
<p>Omnidirectional capsule. Includes W90 windshield.</p>		
		
CK92	AKG0040	RRP: £257.50

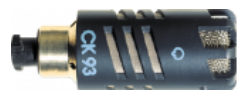
CK93		
<p>Hypercardioid capsule. Includes W90 windshield.</p>		
		
CK93	AKG0093	RRP: £283.33

CK98		
		
Shotgun capsule. Includes W90 windshield.		
CK98	AKG0048	RRP: £511.66

Vocal & Instrument Microphones

C12 VR		
Replica of the original C 12, from the capsule sound to the original 6072A vacuum tube. 9 remotely selectable polar patterns. Includes aluminium carry case, PSU, cable, windscreen and spider shock mount.		
		
C12 VR	AKG0076	RRP: £4,783.33

C414-XLS		
Large-diaphragm condenser microphone for universal applications. Nine selectable pickup patterns enable the user to choose the perfect setting for every application. Lock Mode: all controls can be disabled easily for trouble-free use. Peak Hold LED detects shortest overload peaks. Incredible dynamic range of 152 dB.		
		
C414 XLS	AKG0087	RRP: £966.66

C414-XLS/ST Stereo Pair		
Large-diaphragm condenser microphone for universal applications. Nine selectable pickup patterns enable the user to choose the perfect setting for every application. Lock Mode: all controls can be disabled easily for trouble-free use. Peak Hold LED detects shortest overload peaks. Incredible dynamic range of 152 dB. Stereo pair, matched to within 1dB and including mounting bar.		
		
C414 XLS MATCHED PAIR	AKG0757	RRP: £2,007.50

C414-XLII		
Large-diaphragm condenser microphone, especially for recording of solo vocals and solo instruments. Nine selectable pickup patterns. Lock Mode: all controls can be disabled easily for trouble-free use. Peak Hold LED even detects shortest overload peaks. Incredible dynamic range of 152 dB.		
		
C414 XLII	AKG0086	RRP: £955.00

C414 XLII/ST Stereo Pair		
Large-diaphragm condenser microphone, especially for recording of solo vocals and solo instruments. Nine selectable pickup patterns. Lock Mode: all controls can be disabled easily for trouble-free use. Peak Hold LED even detects shortest overload peaks. Incredible dynamic range of 152 dB. Stereo pair, matched to within 1dB and including mounting bar.		
		
C414 XLII MATCHED PAIR	AKG0758	RRP: £2,016.67

C314		
Designed for enthusiasts and professionals alike, the C314 has advanced features that help artists fine-tune their signature sound including four selectable polar patterns, the lowest self-noise in its class, and an overload detection LED.		
		
C314	AKG1056	RRP: £550.00

C314 Matched Stereo Pair		
Factory-matched stereo set of C314 microphones. The set includes 2x C314, 2x W214 windscreens, 2x H85 suspension mounts, 2x SA60 stand adaptors and an H50 stereo bar, all in a metal carry/storage case.		
		
C314 MATCHED PAIR	AKG1058	RRP: £1,189.17

C214		
<p>Designed as a cost-effective alternative to the C414 family, using one side of the C414 capsule system and AKG's back-plate technology. 20dB attenuation pad, 13dB noise floor, low cut switch. Includes carry case, windscreen and spider suspension mount. Also available as a stereo pair including stereo mounting bar.</p>		
		
C214	AKG0674	RRP: £365.00

C214 Stereo Pair		
<p>Designed as a cost-effective alternative to the C414 family, using one side of the C414 capsule system and AKG's back-plate technology. 20dB attenuation pad, 13dB noise floor, low cut switch. Includes carry case, windscreen and spider suspension mount. Stereo pair including stereo mounting bar.</p>		
		
C214 MATCHED PAIR	AKG0699	RRP: £849.17

C451 B		
<p>Integrated cardioid condenser. Same acoustic performance as the popular original C451EB + CK1 but with dramatically improved specifications. All metal body with excellent RF rejection and almost totally insensitive to handling noise. Ideal for accurately capturing drums and percussion and for overhead micing. Also available as a stereo pair, matched to within 1dB of each other and including stereo mounting bar.</p>		
		
C451 B	AKG0029	RRP: £298.33

C451 B Matched Pair		
<p>Integrated cardioid condenser. Same acoustic performance as the popular original C451EB + CK1 but with dramatically improved specifications. All metal body with excellent RF rejection and almost totally insensitive to handling noise. Ideal for accurately capturing drums and percussion and for overhead micing. Stereo pair, matched to within 1dB of each other and including stereo mounting bar.</p>		
		
C451 B MATCHED PAIR	AKG0105	RRP: £665.83

C3000		
<p>The C3000 high-performance, large-diaphragm condenser microphone has been a standard for live applications and studio recording for almost two decades. It is an excellent choice for vocals, electric and acoustic guitars, drum overhead and brass instrument miking. The switchable attenuation pad and low-cut filter enable high SPL up to 150dB and eliminate proximity effect. The redesigned C3000 presents itself as a cost-effective, rugged workhorse with a sleek and classy finish.</p>		
		
C3000	AKG0713	RRP: £201.67

C1000S MK IV		
<p>Updated version of the ever popular small-diaphragm condenser mic. Now powered by 2xAAA batteries for longer life and cheaper running costs, or phantom power. Two polar patterns - cardioid and hypercardioid - three frequency settings and two gain settings.</p>		
		
C1000S	AKG0933	RRP: £145.83

D12 VR		
<p>Premium kick drum mic. Thin diaphragm within newly designed capsule featuring original C414 transformer from the 1970s. With phantom power disabled, the D12 delivers accurate, pure character from the sound source. With phantom power enabled, one of three switchable active-filter presets can be used to quickly adapt the mic's response.</p>		
		
D12 VR	AKG0912	RRP: £420.00

D112 MKII		
<p>The D112 MkII professional dynamic bass drum microphone features a new integrated flexible mount, while retaining all the sonic strengths that have made it's predecessor the industry-standard. Over the years the D112 has earned a well-deserved reputation as one of the best bass drum microphones ever made, for its high SPL capability, punchy EQ and bulletproof construction.</p>		
		
D112 MKII	AKG1057	RRP: £151.67

D40		
Dynamic instrument mic designed for drums, wind instruments and guitar amps. Patented AKG Varimotion diaphragm. Custom built capsule mounting. Rugged metal body with spring steel wire mesh cap. Includes versatile H440 mounting bracket.		
D40	AKG0667	RRP: £90.00

Handheld Vocal & Instrument Microphones

C636		
Master reference condenser vocal microphone. The AKG C636 is the legendary C535 updated for today's rigorous live performance requirements. Its proprietary double shock suspension system provides unparalleled rejection of handling noise, and a state-of-the-art, multi-layer pop noise rejection system eliminates plosives. Consistent, cardioid polar pattern that eliminates feedback.		
C636 BLK	AKG1155	RRP: £450.83

C7		
Reference condenser vocal microphone. With pristine clarity and sparkling high end, the C7 allows lead and background vocals to shine through. Custom-tuned supercardioid condenser capsule. Open-space capsule design for excellent gain before feedback. Mechano-pneumatic shock absorber suspension eliminates handling noise. Multi-layer pop noise protection eliminates plosives. Patented ultralight 24-karat gold AKG capsule technology guarantees highest durability.		
C7	AKG1143	RRP: £205.00

C5		
Professional condenser microphone for on-stage use. Cardioid polar pattern gives maximum gain before feedback. Removable presence boost adaptor or increased intelligibility. Dent-resistant steel grille and zinc-alloy die-cast housing for maximum protection and durability.		
C5	AKG0629	RRP: £185.00

D7		
Reference quality dynamic vocal mic. Delivers the subtle, open sound of a condenser while retaining the rugged reliability of a dynamic. Patented AKG Laminated Varimotion diaphragm. Built-in low cut filter cuts out unwanted low frequencies, handling noise and provides superior audio clarity. 'S' model has on/off switch.		
D7	AKG0694	RRP: £145.83
D7S	AKG0695	RRP: £153.33

D5		
Extremely rugged handheld dynamic vocal microphone with crisp sound that cuts through any mix. Patented AKG Laminated Varimotion diaphragm. Super-cardioid polar pattern for high gain before feedback. Internal dual shockmount eliminates handling noise. 'S' model has on/off switch.		
D5	AKG0625	RRP: £76.67
D5S	AKG0627	RRP: £85.83

P5i		
The AKG P5i high-performance dynamic vocal microphone delivers powerful sound for lead vocals. Its supercardioid polar pattern ensures utmost gain before feedback and suppresses ambient noise—even on the loudest stages. P5i also features a heavy-duty metal body to withstand tough stage performances, and an integrated windscreen that efficiently eliminates pop and wind noise. And best of all, the AKG P5i features embedded HARMAN ioSYS technology so it automatically configures with the HARMAN Con...		
P5i	AKG1154	RRP: £74.17

Project Studio Line

P170		
Small-diaphragm condenser microphone for recording of overheads, percussions, acoustic guitars and other strings. 1/2-inch true condenser transducer diaphragm delivers outstanding clarity and transient response.		
P170	AKG1012	RRP: £78.33

P120		
The P120 is a 2/3-inch diaphragm true condenser microphone that offers solidly built quality, outstanding performance and excellent value.		
		
P120	AKG1011	RRP: £102.50

P220		
Large-diaphragm true condenser microphone offering a warm and clear sound for lead vocals, acoustic guitar and brass instruments. Switchable bass-cut filter and attenuation pad, suitable for pressure levels up to 155dB SPL. Spider mount and aluminium case included.		
		
P220	AKG1013	RRP: £164.17

P420		
Multi-pattern large diaphragm true condenser microphone offering high sensitivity and 155dB maximum SPL. Three selectable polar patterns - cardioid, omnidirectional and figure 8. Spider mount and aluminium carry case included.		
		
P420	AKG1014	RRP: £197.50

P820 Tube		
		
High-performance multi-pattern tube microphone. With its dual one-inch diaphragm capsule and the advanced ECC83 dual-triode circuitry, the P820 Tube delivers real tube sound and raises the bar in its class of affordable tube microphones.		
P820 TUBE	AKG1015	RRP: £479.17

Perception Live Series

P2		
Rugged all metal microphone for bass instruments such as bass drum, trombone or bass amplifier. Handles highest sound pressure levels. Complete with carrying case.		
P2	AKG0089	RRP: £85.00

P3 S		
Rugged performance microphone designed for backing vocals and instruments. Rugged wire mesh cap with internal windscreen. Complete with stand adapter and zip bag.		
P3 S	AKG0091	RRP: £37.50

P4		
Dynamic microphone designed for drums and percussion, wind instruments and guitar amps. Response tailored for neutral reproduction of instrument sounds. Integrated stand adapter and external bracket.		
P4	AKG0095	RRP: £57.50

P5S		
Dynamic handheld microphone for lead vocals. Super cardioid polar pattern. Die-cast metal body. Complete with stand adapter and zip bag With on/off switch.		
P5 S	AKG0101	RRP: £42.50

P5i		
<p>The AKG P5i high-performance dynamic vocal microphone delivers powerful sound for lead vocals. Its supercardioid polar pattern ensures utmost gain before feedback and suppresses ambient noise—even on the loudest stages. P5i also features a heavy-duty metal body to withstand tough stage performances, and an integrated windscreen that efficiently eliminates pop and wind noise. And best of all, the AKG P5i features embedded HARMAN ioSYS technology so it automatically configures with the HARMAN Con...</p>		
		
P5i	AKG1154	RRP: £74.17

Drum Microphone Sets

Drum Set Premium		
<p>Premium selection of AKG microphones. 1x D12VR, 2x C214, 1x C451B, 4x D40 plus K&M 24030 clips.</p>		
		
DRUMSET PREMIUM	AKG0934	RRP: £1,626.67

Drum Set Session 1		
<p>Ideal all in one drum mic kit featuring seven AKG Perception Live series microphones and accessories packed in a durable aluminium carrying case. The set contains 1x P2 bass drum mic, 2x P17 for overheads and 4x P4 for snare and toms.</p>		
		
DRUMSET SESSION 1	AKG1032	RRP: £321.67

Integrated Systems Conference Systems CS3 Discussion System

CS3 BU		
		
<p>Base station for CS3 conference system. Controls upto 60 delegate or chairman units. Plug-and-play setup. RS232 port for camera control. Expansion port to connect two CS3 BU together to create systems of up to 120 delegates.</p>		
CS3 BU	AKG0937	RRP: £1,622.50

CS3 DU		
<p>Delegate station for CS3 system. Speak button, loudspeaker, two headphone jacks. Plug and play operation. Includes 2m connection cable. 30cm or 50cm gooseneck microphone.</p>		
		
CS3 DU 30	AKG0942	RRP: £435.00
CS3 DU 50	AKG0944	RRP: £432.50

CS3 CU		
<p>Chairman station for CS3 system. Priority Call and Next In Line functions. Speak button, loudspeaker, two headphone jacks. Plug and play operation. Includes 2m connection cable. 30cm or 50cm gooseneck microphone.</p>		
		
CS3 CU 30	AKG0943	RRP: £510.00
CS3 CU 50	AKG0945	RRP: £520.00

CS3 system cables		
<p>Connecting cables for the CS3 discussion system. Available in 2m, 5m, 10m, 20m, 50m and 100m lengths.</p>		
CS3EC002	AKG0948	RRP: £40.00
CS3EC005	AKG0949	RRP: £80.00
CS3EC010	AKG0950	RRP: £110.00
CS3EC020	AKG0951	RRP: £230.00
CS3EC050	AKG0952	RRP: £628.33
CS3EC100	AKG0953	RRP: £952.50

Microphones

CS321		
<p>Cardioid gooseneck microphones with DAM+ connector for fitting to CS3 stations. 30cm long.</p>		
		
CS321	AKG0946	RRP: £129.17

Cables

CS3TC



Two-way splitter for CS3 discussion system.

CS3TC	AKG0956	RRP: £70.00
-------	---------	-------------

Automatic Microphone Mixers

DMM8 (U/UL/ULD)



Digital automatic microphone mixer ideal for large meetings and conferences. Its DSP function ensures precise mixing of up to 80 channels by cascading up to 10 DMM8 U mixers. Two additional stereo audio outputs and one stereo USB offer additional routing options. Numerous DSP functions such as filters, compressor/limiter, ducking and routing make the DMM8 U a great fit in a variety of spoken word applications. UL version includes a LAN interface, ULD includes a Dante® interface.

DMM8 U	AKG1061	RRP: £2,905.00
DMM8 ULD	AKG1067	RRP: £4,336.67

DMM14 (U/UL/ULD)



Digital automatic microphone mixer ideal for large meetings and conferences. Precise mixing of up to 140 channels by cascading up to 10 DMM14 U mixers. Two additional stereo audio outputs and one stereo USB offer additional routing options. Numerous DSP functions such as filters, compressor/limiter, ducking and routing. UL version includes a LAN interface, ULD includes a Dante® interface.

DMM14 U	AKG1062	RRP: £3,810.83
DMM14 UL	AKG1064	RRP: £3,875.00
DMM14 ULD	AKG1068	RRP: £5,242.50

Wireless

Wireless Microphones DMS800

DSR800



The DSR800 reference two-channel digital wireless receiver provides an ultra-wide bandwidth of up to 150MHz for reliable operation with the flexibility to meet the needs of a wide range of applications. It is designed to work with the versatile DHT800 handheld transmitter, which offers interchangeable microphone capsules, and the DPT800 body-pack transmitter, for line- and microphone signals.

DMS800 DSR800 BD1 UK	AKG1074	RRP: £1,761.67
DMS800 DSR800 BD2	AKG1038	RRP: £1,761.67

DPT800

Reference digital wireless body-pack transmitter for use with the DSR800 wireless receiver. Provides an ultra-wide bandwidth of 150 MHz and a selectable radio output power of 10- 50mW. The transmitter can be programmed remotely via infrared data transmission from the DSR800 receiver, and signal security is ensured through the use of 512-bit encryption technology.



DMS800 DPT800 BD1 UK	AKG1073	RRP: £520.00
DMS800 DPT800 BD2	AKG1036	RRP: £520.00

DHT800

The DHT800 reference digital wireless handheld transmitter for use with the DMS800 digital wireless microphone system. It features a robust and slim metal body for durability and easy handling and offers a new level of flexibility with interchangeable microphone heads – users can choose from among the AKG D5 WL1, D7 WL1 or the C5 WL1.



DMS800 DHT800 BD1 UK	AKG1072	RRP: £468.33
DHT800 BD2	AKG1034	RRP: £350.00

D7 WL1

D7 dynamic capsule with threaded connection for use with DMS800 and WMS4500 handheld transmitters



D7 WL1	AKG0710	RRP: £170.00
--------	---------	--------------

D5 WL1		
D5 dynamic capsule with threaded connection for use with DMS800 and WMS4500 handheld transmitters.		
		
D5 WL1	AKG0649	RRP: £150.00

C636 WL1		
C636 condenser microphone capsule for use with DMS800 and WMS4500 handheld systems.		
		
C636 WL1	AKG1156	RRP: £450.83

C5 WL1		
C5 condenser capsule with threaded connection for use with DMS800 and WMS4500 handheld transmitters.		
		
C5 WL1	AKG0650	RRP: £220.00

CU800		
Charging station for DHT800 and DPT800. Two universal charging slots with two hour quick for up to eight hours battery life. Optional 2U rack mount unit. Also compatible with DMS700 components.		
		
DMS800 CU800	AKG1070	RRP: £566.67

DMS100

DMS100 Microphone Set		
		
Plug-and-play 2.4GHZ digital wireless system. Global, licence-free operation. 256 bit AES encryption. Adaptive channel selection. Working range up to 30m. Four DMS100 systems can be used simultaneously. PT100 beltpack transmitter with 3-pin mini XLR input, compatible with AKG micro microphones and instrument cable. Up to 12 hours operation from 2x AA batteries. Set includes PT100 beltpack transmitter, SR100 stationary receiver, universal power supply, instrument cable and batteries.		
DMS100 Vocal Set Digital Wireless Microphone System	AKG1177	RRP: £261.67

DMS100 Instrument Set		
		
Plug-and-play 2.4GHZ digital wireless system. Global, licence-free operation. 256 bit AES encryption. Adaptive channel selection. Working range up to 30m. Four DMS100 systems can be used simultaneously. HT100 handheld transmitter with P5 dynamic microphone capsule. Up to 12 hours operation from 2x AA batteries. Set includes HT handheld transmitter transmitter, SR100 stationary receiver, universal power supply, instrument cable and batteries.		
DMS100 Instrument Set Digital Wireless Microphone System	AKG1176	RRP: £261.67

DMS300

DMS300 Microphone Set



Plug-and-play 2.4GHZ digital wireless system. Global, licence-free operation. 256 bit AES encryption. Adaptive channel selection. Working range up to 30m. Eight DMS300 systems can be used simultaneously. HT300 handheld transmitter with P5 dynamic microphone capsule. Up to 12 hours operation from 2x AA batteries. SR300 receiver with high resolution display that allows easy setup, monitoring and control. Ethernet sync in and out ports. Set includes HT300 handheld transmitter, SR300 stationary receiver, universal power supply and batteries.

DMS300 Vocal Set Digital Wireless Microphone System	AKG1179	RRP: £355.83
---	---------	--------------

DMS300 Instrument Set



Plug-and-play 2.4GHZ digital wireless system. Global, licence-free operation. 256 bit AES encryption. Adaptive channel selection. Working range up to 30m. Eight DMS300 systems can be used simultaneously. HT300 beltpack transmitter with mini 3-pin XLR connector, compatible with AKG microphones and instrument cable. Up to 12 hours operation from 2x AA batteries. SR300 receiver with high resolution display that allows easy setup, monitoring and control. Ethernet sync in and out ports. Set includes PT300 beltpack transmitter, SR300 stationary receiver, universal power supply, instrument cable and batteries.

DMS300 Instrument Set Digital Wireless Microphone System	AKG1178	RRP: £355.83
--	---------	--------------

DMS Tetrad v2

DMS Tetrad Mixed Set v2



Set containing DSR Tetrad v2 receiver with 1 x DHT Tetrad handheld transmitter D5 and 1x DPT Tetrad pocket transmitter

DMS TETRAD MIXED SET EU	AKG1078	RRP: £694.17
-------------------------	---------	--------------

WMS4500

Accessories

MK PS

Connecting cable for PS4000 to SR4000.



MK PS	AKG0247	RRP: £20.00
-------	---------	-------------

RMS4000

Remote mute switch for PT 4500.



RMS4000	AKG0670	RRP: £87.50
---------	---------	-------------

WMS470

WMS470 D5 Vocal Set



The WMS 470 Set with the outstanding sound of the D5 microphone. Includes SR 470 receiver, HT 470 D5 transmitter, PSU, AA battery, mic clip, 2 antennas and rack mount kit. Band 9U for Channel 38, Band 6 for Channel 70/ISM

WMS470 D5 SET BD9-U-10MW	AKG0833	RRP: £680.00
--------------------------	---------	--------------

WMS470 Instrument Set



Wireless system for a wide variety of instruments. Includes SR 470 receiver, PT 470 transmitter, MKG L instrument cable, PSU, AA battery, mic clip, 2 antennas and rack mount kit. Band 9U for Channel 38, Band D for Channel 70/ISM.

WMS470 INSTR SET BD9-U-50MW	AKG0835	RRP: £680.00
WMS470 INSTR SET BD D-10MW	AKG1025	RRP: £680.00

WMS470 Sports Set



Wireless system for aerobics/fitness applications. Includes SR 470 receiver, PT 470 transmitter, C 544 L headworn microphone, PSU, AA battery, mic clip, 2 antennas and rack mount kit. Band 9U for Channel 38, Band D for Channel 70/ISM.

WMS470 Sports Set 9U	AKG0836	RRP: £505.00
WMS470 SPORTS SET BD D-10MW	AKG1026	RRP: £808.33

WMS470 Presenter Set



The perfect WMS 470 Set for professional presentations and all types of broadcast and theatrical applications. Includes SR 470 receiver, PT 470 transmitter, C 555 L headworn and CK 99 lavalier microphones, PSU, AA battery, mic clip, 2 antennas and rack mount kit. Band 9U for Channel 38, Band D for Channel 70/ISM.

WMS470 PRES SET BD9-U-50MW	AKG0837	RRP: £860.00
----------------------------	---------	--------------

Components

PT470

Compact belt pack transmitter for WMS 470 systems. Up to 50mW output power. Long battery life (14 hours with single AA lithium battery). Battery level display. Noiseless on/off switch. Integrated charging contacts. IR link for instant setup. Mini XLR audio input. Connector for external mute switch.



PT470 - Band 6A	AKG0821	RRP: £215.00
PT470 BD9-U-50MW	AKG0839	RRP: £170.00

Accessories

CU400

Charger and batteries. Can charge two batteries simultaneously to full capacity within one hour and without removing the batteries from the transmitters.



CU400 EU/US/UK	AKG0451	RRP: £355.00
----------------	---------	--------------

WMS420

WMS420 Vocal Set



Single channel wireless system with assignable frequency selection. Compatible with the CU400 charging station and AKG's external antenna components. Set consists of SR420 receiver, power supply and HT420 handheld transmitter with D5 capsule. Band U1 for Channel 38, band D for licence-free ISM/Channel 70.

WMS420 VOCAL SET Band U1	AKG0984	RRP: £256.67
WMS420 VOCAL SET Band D	AKG0983	RRP: £256.67

WMS420 Instrument Set



Single channel wireless system with assignable frequency selection. Compatible with the CU400 charging station and AKG's external antenna components. Set consists of SR420 receiver, power supply and PT420 belt pack transmitter with MKGL instrument cable. Band U1 for Channel 38, band D for licence-free ISM/Channel 70.

WMS420 INSTRUMENTAL SET Band U1	AKG0980	RRP: £274.17
WMS420 INSTRUMENTAL SET Band D	AKG0979	RRP: £274.17

WMS420 Presenter Set



Single channel wireless system with assignable frequency selection. Compatible with the CU400 charging station and AKG's external antenna components. Set consists of SR420 receiver, power supply, PT420 belt-pack transmitter and C417L lavalier microphone. Band U1 for Channel 38, band D for licence-free ISM/Channel 70.

WMS420 PRESENTER SET Band U1	AKG0982	RRP: £274.17
WMS420 PRESENTER SET Band D	AKG0981	RRP: £274.17

WMS420 Headset Set



Single channel wireless system with assignable frequency selection. Compatible with the CU400 charging station and AKG's external antenna components. Set consists of SR420 receiver, power supply, PT420 belt-pack transmitter and C555L head worn microphone. Band U1 for Channel 38, band D for licence-free ISM/Channel 70.

WMS420 HEADWORN SET Band U1	AKG0978	RRP: £325.00
WMS420 HEADWORN SET Band D	AKG0977	RRP: £325.00

WMS420 Components

HT420

Analog high-performance wireless handheld transmitter with cardioid polar parrern. With gain control and long battery life with a single AA battery and patented state-of-the-art D5 dynamic capsule.



HT420 Band D	AKG0998	RRP: £153.33
HT420 Band U1	AKG0999	RRP: £153.33

PT420

Analog high-performance wireless body-pack transmitter with professional mini XLR audio connector. Compatible with all AKG MicroMics



PT420 Band D	AKG1000	RRP: £110.83
PT420 Band U1	AKG1001	RRP: £110.83

SR420

Analog high-performance space diversity wireless receiver with upto eight channel presets and upto 30MHz selection bandwidth. Audio clipping and RF signal LED, professional XLR and 1/4" jack connector. Comes with two external and detachable antennas and BNC connectors at 50ohms.



SR420 Band D	AKG1002	RRP: £162.50
SR420 Band U1	AKG1003	RRP: £162.50

WMS45 Perception Wireless

Perception Wireless Vocal Set

Complete multi-channel wireless vocal set. 30MHz selectable bandwidth. The HT 45 handheld transmitter provides up to 8 hours operation from a single (supplied) AA battery, gain control and noiseless on/off/mute switch. SR 45 receiver has XLR and TRS outputs, RF and audio level indicators and adjustable gain and squelch controls. SA 45 mic clip and UK power supply. Band D operates on licence-free channel 70 (ISM) frequencies.



Perception Wireless 45 Vocal Set BD D	AKG0797	RRP: £193.33
---------------------------------------	---------	--------------

Perception Wireless Instrument Set

Multi-channel wireless instrument set. 30MHz selectable bandwidth. The PT 45 pocket transmitter is compatible with all AKG micro mics and provides up to 8 hours operation from a single (supplied) AA battery, gain control and noiseless on/off/mute switch. SR45 receiver as above. Instrument cable and UK power supply. Band D operates on licence-free channel 70 (ISM) frequencies.



Perception Wireless 45 Instr Set BD D	AKG0794	RRP: £193.33
---------------------------------------	---------	--------------

Perception Wireless Presenter Set



Multi-channel wireless system with lavalier microphone. 30MHz selectable bandwidth. The PT 45 pocket transmitter is compatible with all AKG micro mics including the supplied CK 99 L lavalier mic, and provides up to 8 hours operation from a single (supplied) AA battery, gain control and noiseless on/off/mute switch. SR45 receiver as above. UK power supply included. Band D operates on licence-free channel 70 (ISM) frequencies.

Perception Wireless 45 Pres Set BD D	AKG0795	RRP: £193.33
--------------------------------------	---------	--------------

Perception Wireless Sport Set

Multi-channel wireless set with headworn microphone. 30MHz selectable bandwidth. The PT 45 pocket transmitter is compatible with all AKG micro mics including the supplied C 544 headworn mic, and provides up to 8 hours operation from a single (supplied) AA battery, gain control and noiseless on/off/mute switch. SR45 receiver as above. UK power supply included. Band D operates on licence-free channel 70 (ISM) frequencies.



Perception Wireless 45 Sports Set BD D	AKG0796	RRP: £249.17
--	---------	--------------

WMS40 MINI

WMS40 MINI Vocal Set

Plug-and-play wireless. HT40 handheld transmitter with dynamic capsule provides 30 hours operation from a single AA battery. SR40 Mini receiver with RF and Clip LED indicators, 1/4" jack output. Universal power supply included. Operates on licence-free ISM frequency range.



WMS40 Mini Vocal Set BD ISM1	AKG0799	RRP: £99.17
WMS40 Mini Vocal Set BD ISM2	AKG0800	RRP: £99.17
WMS40 Mini Vocal Set BD ISM3	AKG0801	RRP: £99.17

WMS40 MINI Instrument Set



Plug-and-play wireless. The PT40 MINI belt pack transmitter comes with instrument cable and is compatible with all AKG MicroMics. 30 hours operation from a single AA battery. SR40 Mini receiver with RF and Clip LED indicators, 1/4" jack output. Universal power supply included. Operates on licence-free ISM frequency range.

WMS40 Mini Instrumental Set BD ISM1	AKG0802	RRP: £102.50
WMS40 Mini Instrumental Set BD ISM2	AKG0803	RRP: £102.50
WMS40 MINI Instrument Set - ISM3	AKG0804	RRP: £74.17

WMS40 MINI Dual Instrument



Dual channel plug-and-play wireless. Each of the two included bodypack transmitters has a 3-pin mini XLR connector compatible with all guitars, basses and AKG's MicroMics and gives 30 hours operation from a single AA battery. The receiver offers two balanced outputs on 1/4" jack connectors. Fixed frequency on channels ISM2/3

WMS40 Mini2 Instrumental Set BD ISM2/3 EU/US/UK	AKG0853	RRP: £196.67
---	---------	--------------

WMS40 MINI Dual Vocal

Dual channel plug-and-play wireless. Each of the two included handheld transmitters has a dynamic cardioid capsule for maximum gain before feedback and gives 30 hours operation from a single AA battery. The receiver offers two balanced outputs on 1/4" jack connectors. Fixed frequency on channels ISM2/3



WMS40 Mini2 Vocal Set BD ISM2/3 EU/US/UK	AKG0855	RRP: £162.50
--	---------	--------------

WMS 40 MINI Dual Instrument/Vocal

Dual channel plug-and-play wireless. One handheld transmitter and one beltpack transmitter with instrument cable. The receiver offers two balanced outputs on 1/4" jack connectors. Fixed frequency on channels ISM2/3



WMS40 Mini2 Mix Set BD ISM2/3 EU/US/UK	AKG0854	RRP: £219.17
--	---------	--------------

RMU40MINIPRO

19" rack mounting bracket for WMS40 MINI systems.

RMU40 mini PRO	AKG0904	RRP: £449.17
----------------	---------	--------------

Antenna Systems

AB4000 EW		
AB4000 EW is a high-performance antenna booster to compensate signal loss on long antenna cables. One AB4000 EW can compensate 3.5 to 17.5 dB of cable attenuation. Up to two boosters can be cascaded in case of extremely long cable runs.		
AB4000 EW	AKG1148	RRP: £355.00

ASU4000		
The ASU4000 is a remote antenna power supply unit for large-scale antenna distribution or small antenna systems where no PS4000 W is in use. It provides the necessary power for up to three active antenna elements (RA4000 B/EW, SRA2 B/EW, AB4000 EW) via the antenna cable.		
ASU4000	AKG1149	RRP: £144.17

SRA2 EW		
Passive directional wide-band UHF antenna. Can be used as a transmitting or receiving antenna for wireless microphones and IEM systems. Operates in a frequency range from 470MHz to 952MHz. Provides a covering angle of 70° and an antenna gain of 6dB. Works for short cable lengths up to 10m and supports a professional BNC connector. Water-resistant construction to withstand extreme weather conditions.		
SRA2 EW	AKG1145	RRP: £525.00

RA4000 B/EW		
Active omnidirectional wide-band UHF antenna. Operates in a frequency range from 470MHz to 952MHz, providing a covering angle of 360° and a total gain of 18dB. Built-in amplifier to compensate long cable runs. With dedicated antenna components, it works for cable lengths up to 300m. The RA4000 B/EW is remotely powered through the antenna cable.		
RA4000 B/EW	AKG1146	RRP: £225.00

RA4000 EW		
Passive omnidirectional wide-band UHF antenna that can be used as a transmitting or receiving antenna for wireless microphones and IEM systems. Operates in a frequency range from 470MHz to 952MHz, providing a covering angle of 360° and an antenna gain of 1dB. It works for short cable lengths up to 10m and supports a professional BNC connector.		
RA4000 EW	AKG1147	RRP: £210.83

Helical		
Circular polarized helical antenna is specially designed for tour sound, sports and broadcast applications where long range FOH positions of many hundreds of feet often require high gain. 9dB antenna gain. 470 to 740MHz for universal use worldwide. Foldable from 12" extended to 3" compressed to easily fit inside a rack drawer.		
Helical Antenna	AKG1071	RRP: £756.67

MKA20		
50 Ohm, 20m connecting cable. Gold plated BNC connectors on both ends.		
MKA 20	AKG0245	RRP: £40.83

MKA5		
50 Ohm, 5m connecting cable. Gold plated BNC connectors on both ends.		
MKA 5	AKG0246	RRP: £55.00

AC12/UK		
12V AC PSU, 500mA		
AC12 PSU12V 2000mA Lock EU/US/UK/AU	AKG0004	RRP: £46.35

Headphones

Professional Headphones

K361-BT		
Over-ear, Oval, Closed-Back, Foldable Studio Headphones with Bluetooth. K361-BTs are precision-engineered to reproduce natural, balanced audio in exceptional detail, so you can make more confident decisions when you're mixing and editing. Switchable Bluetooth wireless and wired connectivity.		
K361BT	AKG1189	RRP: £119.17

K371-BT		
Over-ear, Oval, Closed-Back, Foldable Studio Headphones with Bluetooth. K371-BTs are precision-engineered to match AKG's Reference Response acoustic target to reproduce natural, balanced audio in extraordinary detail, so you can make more confident decisions when you're mixing and editing. Switchable Bluetooth wireless and wired connectivity.		
K371BT	AKG1190	RRP: £167.50

K361		
<p>AKG K361 Professional Studio Headphones strike the perfect balance between professional-grade quality and consumer-friendly fit, comfort and portability. Combining cutting-edge performance, extended frequency response and supreme comfort in a closed-back, over-the-ear, folding design, the K361 headphones are perfectly suited for life in the studio or on the go.</p>		
K361	AKG1186	RRP: £102.50



K371		
<p>AKG K371 Professional Studio Headphones strike the perfect balance between professional-grade quality and consumer-friendly fit, comfort and portability. Combining cutting-edge performance, AKG's Reference Response Curve tuning, extended frequency response and supreme comfort in a closed-back, over-the-ear, folding design, the K371 headphones are perfectly suited for life in the studio or on the go.</p>		
K371	AKG1187	RRP: £145.00



K872		
<p>Master reference closed back headphones. Provide unprecedented accuracy and comfort in production and live sound engineering environments. Custom 53mm drivers with 1.5 Tesla magnet systems deliver exceptional headroom for precise imaging, deep low frequencies and extended dynamic range. Two-layer voice coil for superior extended 5Hz – 54kHz frequency range. Open-mesh headband for remarkable comfort and light weight. 3D-shaped slow-retention ear pads for personalized fit. Slim, durable, removable cable with precision LEMO connector. Robust design incorporating precision metal parts.</p>		
K872	AKG1142	RRP: £1,243.33



K812		
<p>The K812 superior reference headphones offer the most pure and natural sound possible. Designed for music professionals the K812 empower to experience the smallest sonic details with the most accurate balance for mixing, mastering as well as music production. The K812 offers an oversized 53mm driver for the highest dynamic range ever in an AKG headphone. Its copper-covered aluminum voice coil extends sounds beyond the limits of human hearing, hitting a full spectrum of frequencies. Each K812 is built for comfort with a fast, adjustable headband and extremely soft ear pads to ensure comfort in any application, for extended periods of time.</p>		
K812 PRO	AKG0975	RRP: £1,205.83



K712 PRO		
<p>The K712 PROs are reference, open, over-ear headphones for precise listening, mixing and mastering. The over-ear design guarantees maximum wearing comfort for fatigue-free mixing and mastering, while providing spacious and airy sound without any compromise. Their precise powerful sound results from improved low-end performance by 3dB. These headphones have a genuine soft leather headband for a lightweight and comfortable fit. Their carefully selected transducers provide consistency and accurate localization. The K712 PROs come with a professional mini XLR connector for quick replacement of the cable. Also included is an additional coiled cable and a premium carrying bag.</p>		
K712 PRO	AKG0972	RRP: £279.17



K702		
<p>Open-back dynamic reference headphones. Flat-wire voice coils and a patented Varimotion™ two-layer diaphragm result in an extremely accurate response. Self-adjusting head band and 3D-form earpads for perfect fit. Detachable cable. Individually tested and numbered.</p>		
K702	AKG0672	RRP: £170.83





K612 PRO		
<p>K612 PRO headphones are reference open, over-ear phones that deliver natural sound imaging for professional monitoring. The advanced open technology offers comfort for long working sessions and a full, spacious sound. AKG's patented Varimotion™ diaphragm technology completes the unique sound of the K612 PRO. Obvious features such as the self-adjusting real leather headband, aluminum arches and solid rivets not only provide a lightweight, maximum comfort fit, but also reinforce the quality AKG has provided to studio engineers for decades.</p>		
K612 PRO	AKG0971	RRP: £145.83



K271 MKII		
<p>Circumaural studio headphones. Self-adjusting headband. Patented Varimotion speakers. High noise attenuation. Automute function when headphones are taken off. Leatherette and velvet earpads. Single-sided, detachable 3m cable and additional 5m coiled cable.</p>		
K271 MKII	AKG0662	RRP: £124.17



K240 MKII		
Semi-open circumaural studio headphones. Self-adjusting headband. Patented Varimotion speakers. High noise attenuation. Leatherette and velvet earpads. Single-sided, detachable 3m cable and additional 5m coiled cable.		
		
K240 MKII	AKG0661	RRP: £78.33

K240 Studio		
The Studio version of these classic hi-fi stereo headphones uses XXL speakers with Varimotion diaphragms for higher sensitivity, a wider dynamic range, and higher sound levels. Other features include semi-open earphones, a solid bass range, clear highs, and excellent comfort.		
		
K240 STUDIO	AKG0224	RRP: £73.33

K92		
Over ear, closed back headphones. 40mm drivers with extended 16Hz - 20kHz frequency response. Lightweight construction for comfort. 3m cable with 3.5mm jack and 1/4" screw-on adaptor.		
		
K92	AKG1133	RRP: £55.83

K72		
Over ear, closed back headphones. 40mm drivers with extended 16Hz - 20kHz frequency response. Lightweight construction for comfort. 3m cable with 3.5mm jack and 1/4" screw-on adaptor.		
		
K72	AKG1132	RRP: £42.50

K52		
Over ear, closed back headphones. 40mm drivers with wide 18Hz - 20kHz frequency response. Lightweight construction for comfort. 2.5m cable with 3.5mm jack and 1/4" screw-on adaptor.		
		
K52	AKG1131	RRP: £33.33

K15		
High performance on-ear conference headphones. Optimal adjustment to any head size and light weight design allow hours of use, while forgetting the presence of these headphones. After the conference wiping with a simple hygienic tissue will prepare the unit for the next user, without the need to exchange expensive foam cushions. 3.5mm jack connector.		
		
K15	AKG1021	RRP: £133.33

Headsets Professional Headsets

HSD 271 mkII		
New version. Professional closed-back headset derived from the K271 headphones. Circum-aural design. Flexible microphone arm with dynamic capsule. Automatic headphone and mic muting. Switchable bass-cut filter. Detachable cable (sold separately).		
		
HSD271	AKG0808	RRP: £427.50

HSC 171 mkII		
New version. Closed-back headset derived from the K171 headphones. Supra-aural design. Flexible microphone arm with condenser capsule. Auto muting. Switchable bass-cut filter. Detachable cable (sold separately)		
		
HSC 171 mkII	AKG0805	RRP: £270.00

HSC 271 mkII		
New version. Professional closed-back headset derived from the K271 headphones. Circum-aural design. Flexible microphone arm with dynamic capsule. Automatic headphone and mic muting. Switchable bass-cut filter. Detachable cable (sold separately).		
		
HSC271	AKG0806	RRP: £427.50

HSC15		
High performance conference headset. Optimal adjustment to any head size and lightweight design allow hours of use, while forgetting the presence of the headset. After the conference wiping with a simple hygienic tissue will prepare the unit for the next user, without the need to exchange expensive foam cushions. Slimline gooseneck microphone with omnidirectional condenser capsule. Two 3.5mm jack connectors for headphone and microphone connections.		
		
HSC15	AKG1022	RRP: £267.50

MK HS Studio C		
For use with HSC171/271 headsets. 3-pin XLR male microphone connector with integral phantom power adaptor. 1/4" TRS headphone connector.		
		
MK HS Studio C	AKG0810	RRP: £120.00

MK HS Studio D		
For use with HSD171/271 headsets. 3-pin XLR male microphone connector. 1/4" TRS headphone connector.		
		
MK HS Studio D	AKG0811	RRP: £80.00

MK HS MiniJack		
For use with HSD171/271 headsets. 3.5mm headphone and 3.5mm mic connectors for computer/conferencing applications.		
		
MK HS MiniJack	AKG0809	RRP: £50.00

MK HS XLR 4D		
For use with HSD171/271 headsets. 4-pin XLR female connector for intercom/broadcast applications.		
		
MK HS XLR 4D	AKG0812	RRP: £75.00

MK HS XLR 5D		
For use with HSD171/271 headsets. 5-pin XLR male connector for camera/intercom applications.		
		
MK HS XLR 5D	AKG0813	RRP: £80.00

Accessories

PF 80 Pop Filter		
Universal pop filter for use with vocal recording microphones.		
		
PF80	AKG0260	RRP: £55.83

H50		
		
Stereo bar for mounting two microphones 60mm to 170mm apart.		
H50	AKG0206	RRP: £34.16

MPA VL		
		
In line XLR phantom power adaptor for ML & L version microphones.		
MPA V L	AKG0637	RRP: £80.00

ST6		
Professional table stand for universal use. The ST6 is compatible with wide range of microphones, e.g. the gooseneck microphones of the Compact and DAM series. Due to its heavy weight it is very well shock absorbing and holds the microphone firm on place.		
		
ST6	AKG0961	RRP: £145.00

ST 45		
Low profile table stand.		
		
ST45	AKG0314	RRP: £75.00

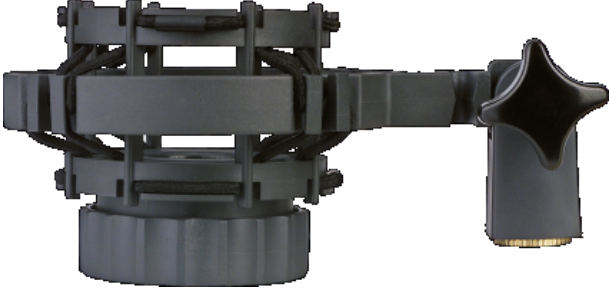
H85		
		
Universal Shockmount for mics with shaft diameters from 19mm to 26mm.		
H85	AKG0473	RRP: £62.50

SA 60		
Stand adaptor for straight shaft microphones.		
		
SA60	AKG0352	RRP: £16.66

SA 63		
Stand adaptor.		
		
SA63	AKG0354	RRP: £24.17

W 23		
50mm foam windscreen for ball head microphones.		
		
W 23	AKG0337	RRP: £20.00

W 30		
Foam windscreen for use with CK 31, CK 32 and CG 33.		
		
W30	AKG0259	RRP: £10.00

W 32		
Foam windscreen 18-20mm for use with CK 61 ULS etc.		
		
W32	AKG0342	RRP: £15.00

EK 300		
Headphone cable. 3m long. 3.5mm jack plug to mini XLR.		
		
EK300	AKG0413	RRP: £16.66

EK 500 S		
Coiled headphone cable. 5m long. 3.5mm jack plug to mini XLR.		
		
EK500 S	AKG0414	RRP: £24.17